

ELENCO PARTI / PARTS LIST

#	QTÀ / QTY	DESCRIZIONE / DESCRIPTION	CODICE / CODE
1	1	DB killer / DB killer	50.DK.020.0
2	1	Silenziatore / Muffler	OVAL
3	1	Protezione in gomma per staffa / Rubber protection for bracket	50.73.041.1
4	1	Staffa / Bracket	50.SS.002.0
5	1	Vite M8x25 / Screw M8x25	50.73.064.1
6	2	Rondella in alluminio / Aluminium washer	50.73.063.1
7	2	Dado M8 flangiato / Flanged nut M8	50.73.393.1
8	1	Distanziale in alluminio / Aluminium spacer (Øe.30 Øi.8,5 h.30)	50.SS.054.1
9	1	Staffa / Bracket	50.SS.003.0
10	1	Vite M8x90 / Screw M8x90	50.73.073.1
11	1	Guarnizione in grafite / Graphite bush	50.73.027.1
12	3	Vite M8x16 / Screw M8x16	50.73.006.1

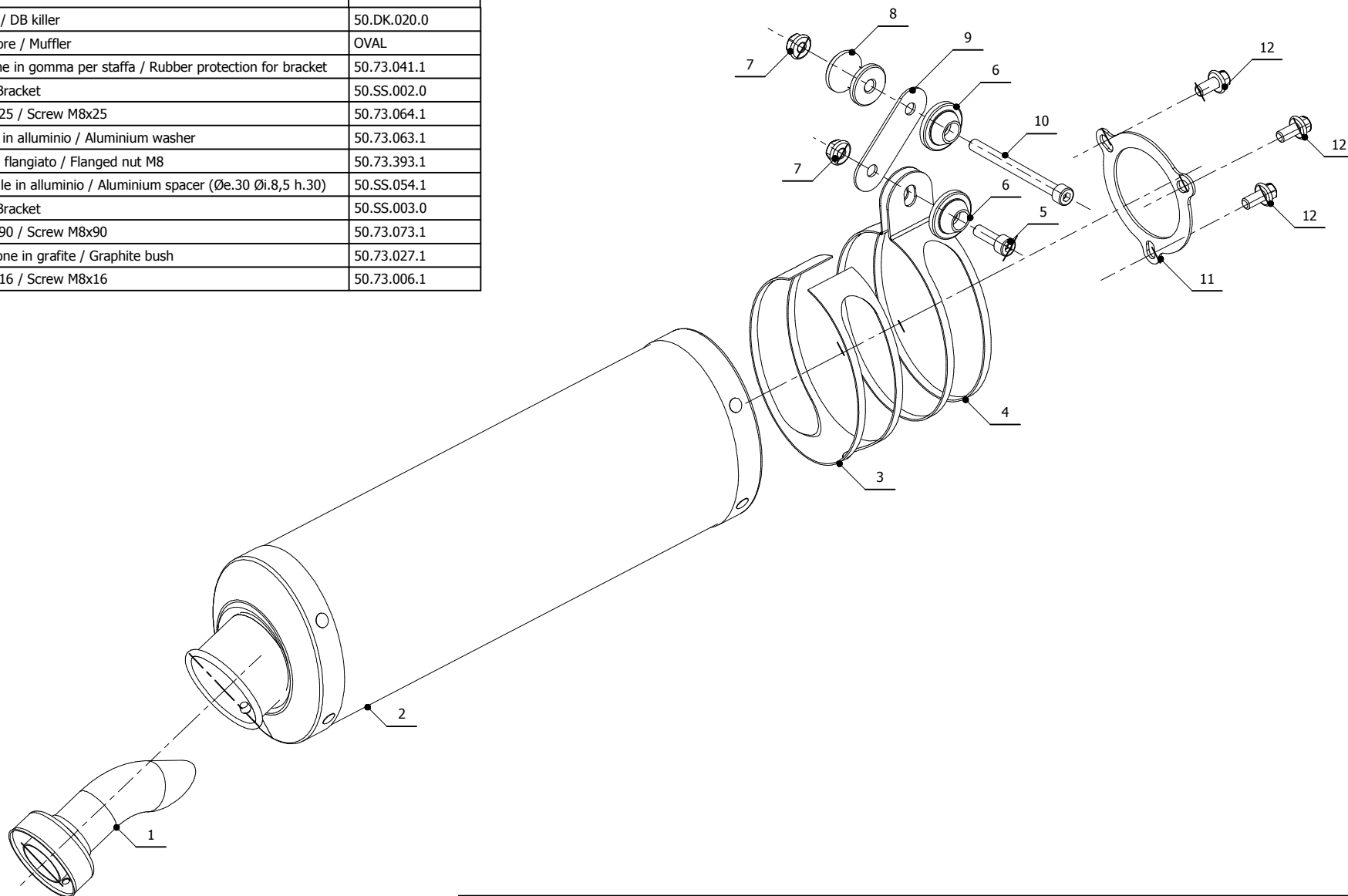

APPLICAZIONI / APPLICATIONS

CODICE / CODE	TUBO / PIPE	SILENZIATORE / MUFFLER	FASCETTA / CLAMP
74.K.008.LX2	///	INOX / ST. STEEL	INOX / ST. STEEL